



Digital Modulation

Nick Massey
VA7NRM

Encoding



-. . - . - . - - . - . . . - - -

Data 0 1 0 0 1 1 0 0 0 1 1 0

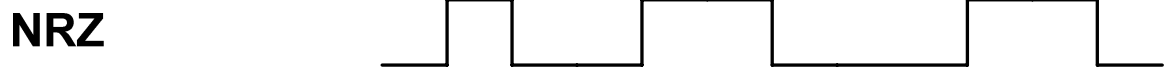

2-bit Symbol

01	00	11	00	01	10
----	----	----	----	----	----

3-bit Symbol

010	011	000	110
-----	-----	-----	-----

Modulation



- What aspects of the RF carrier can we “modulate” to convey the information?

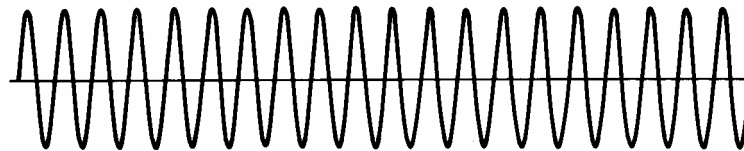

ASK, FSK & PSK

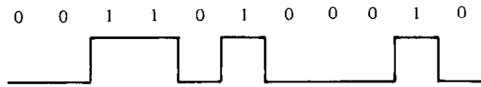

ASK
Amplitude Shift Keying

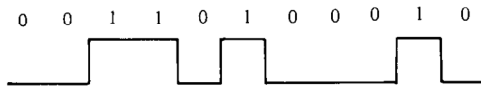

FSK
Frequency Shift Keying

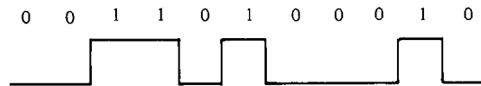

PSK
Phase Shift Keying

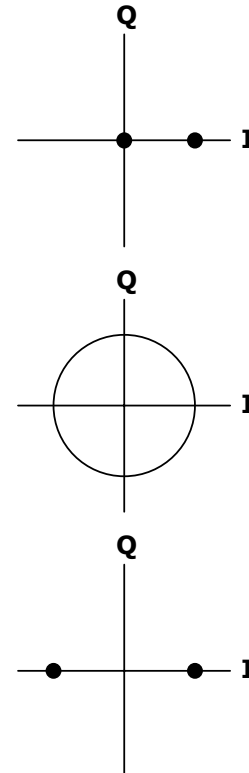

m-ary Modulation



- Conveys more than one bit of data per symbol

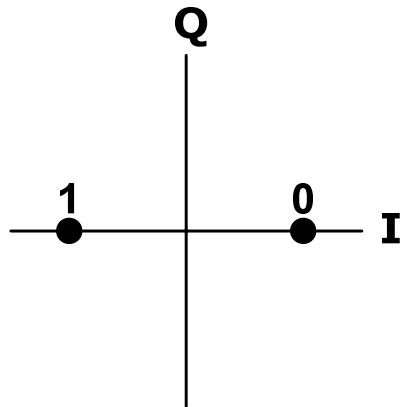

BPSK
Binary PSK

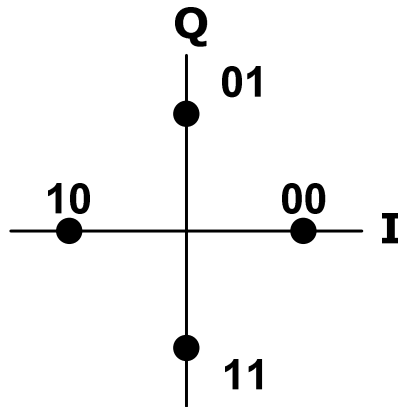

QPSK
Quadrature PSK

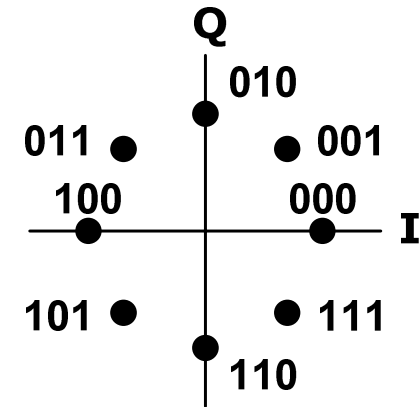

8PSK
8-ary PSK

Complex Modulation

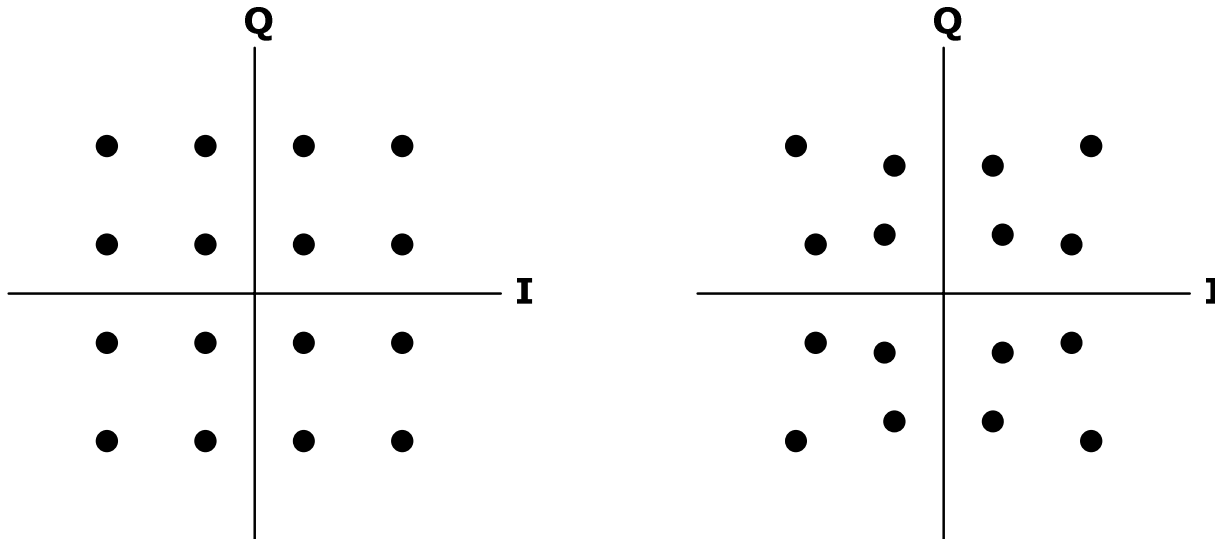

16-QAM
4-bit Symbols

Noise and Interference



— • — • — • — • • • — • — • • • — • • • • — •

■ The signal that is received is usually “contaminated” by Noise and Interference

- **Noise**

- Galactic Noise
- Atmospheric Noise
- Man-made Noise

- **Interference**

- Other Users, Radars, ISM
- “License Free” systems use ISM bands

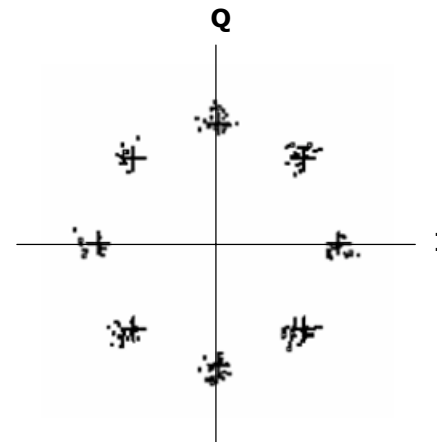

"Eye" Pattern

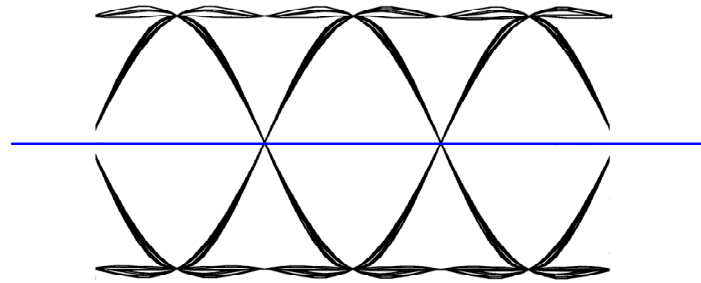

Good Signal /Noise

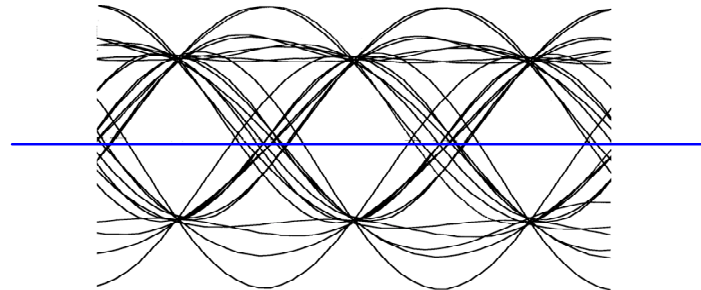

Poor(er) Signal /Noise

Distortion



- The signal that is received is not very often the same as the signal that was transmitted!
 - Fading
 - Narrowband - Multiple paths, signal cancels
 - Fading varies as paths change (radios or obstacles move)
 - Frequency Shift and Frequency Spread (Doppler)
 - Mobile Applications
 - Time Dispersion and Delay Spread
 - Multiple paths, signals arrive with different delays
 - Paths change

Multipath Inter-symbol Interference

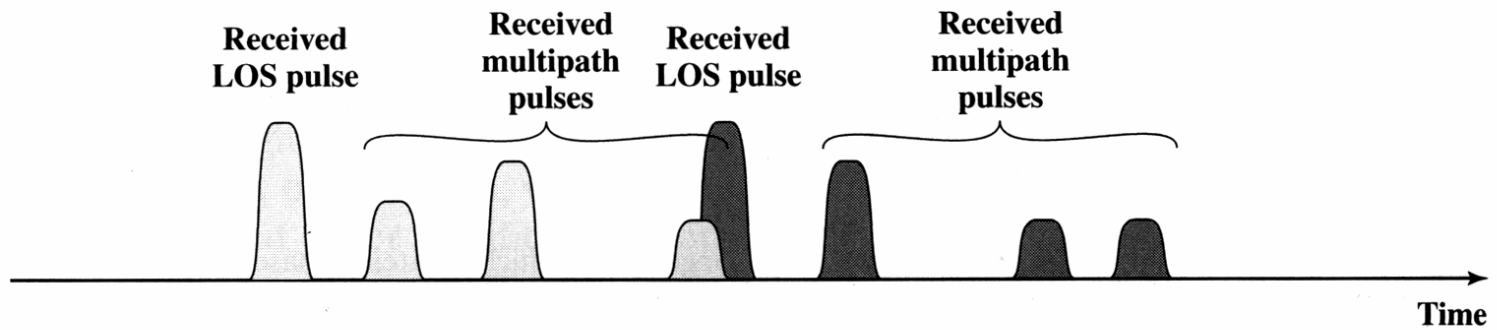
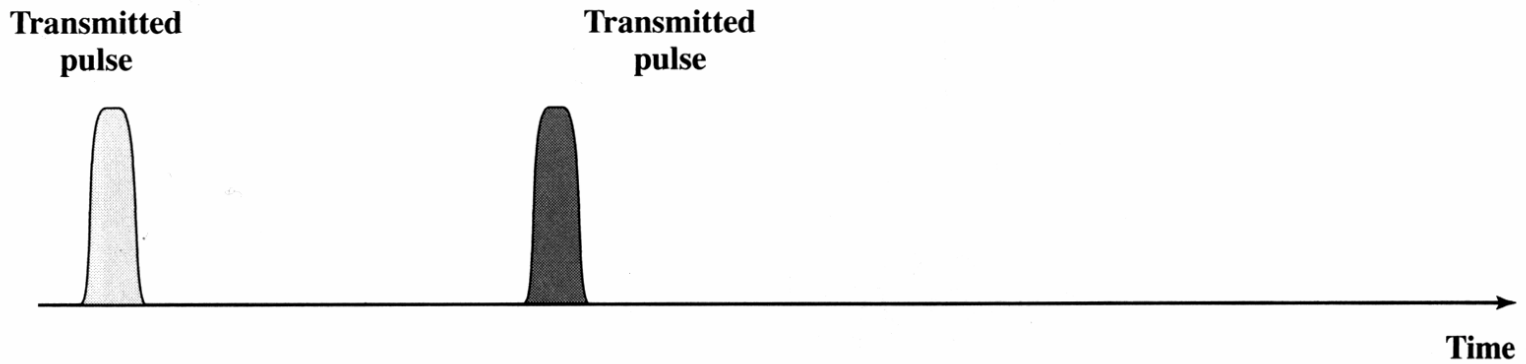

Parallel Modems (OFDM)



■ Combat Inter-Symbol Interference

- Many parallel signals
- Symbol $>$ Multipath Spread

■ Combat Fading

- Few sub-channels lost

■ Modulation

- Usually m-QAM

■ Coding

- FEC
- Interleaving

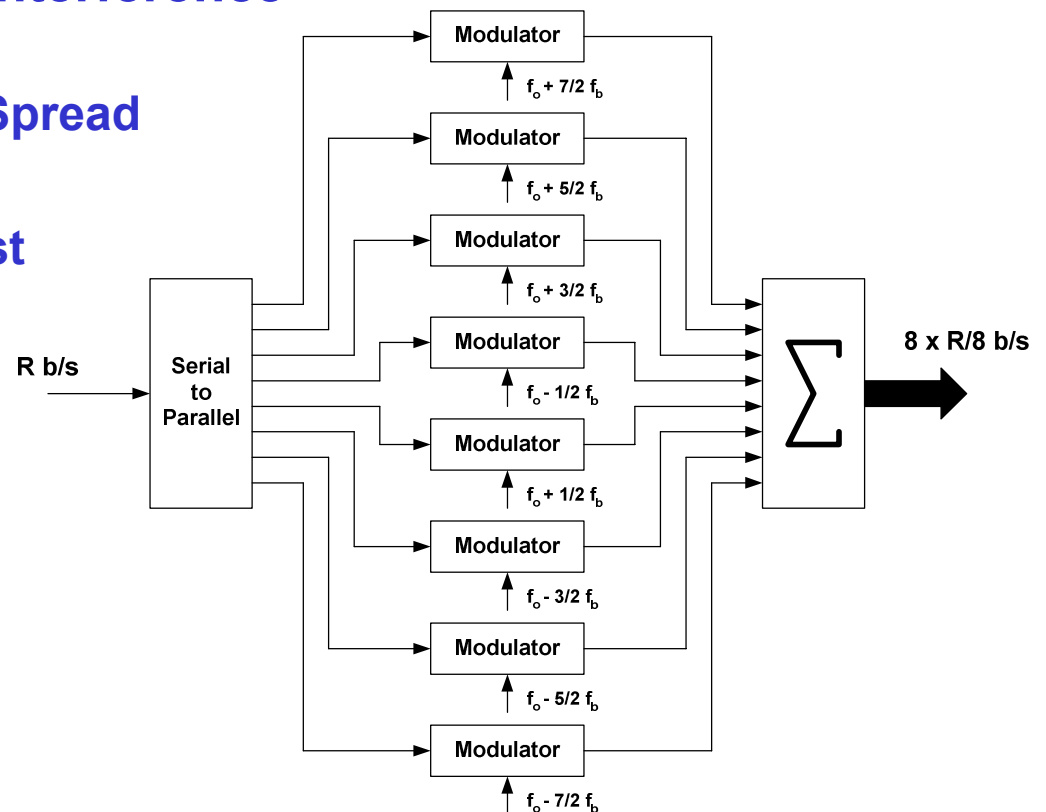

OFDM (16 sub-carriers)

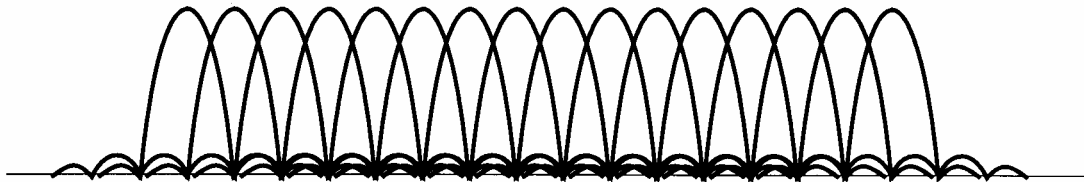

Spread Spectrum



■ Spread Spectrum

- Signal Bandwidth is much greater than Information Bandwidth
- A code, other than the data (message) to be transmitted, determines the actual on-air bandwidth

■ Advantages

- LPI, Anti-DF and Anti-Jam in a Tactical Environment
- Spectrum Sharing
- Resilient against multipath
- "Whitens" noise and interference

Direct Sequence

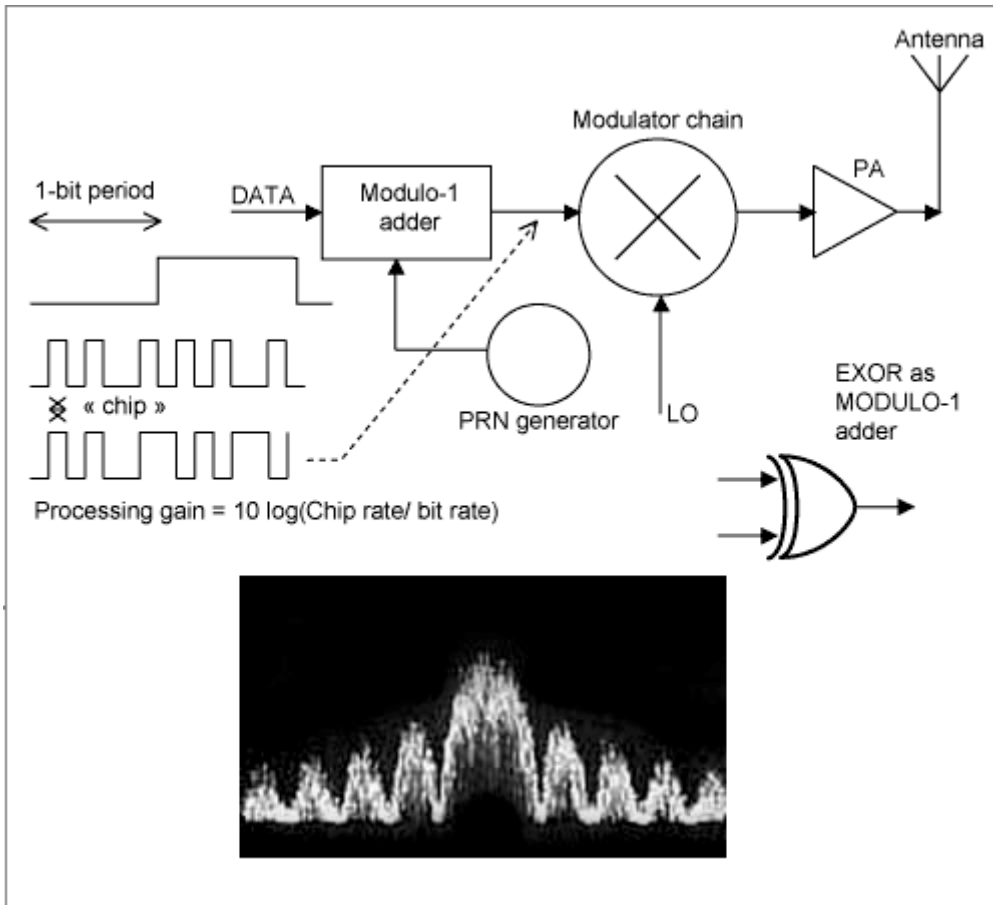

- High-speed code spreads the signal
- “Near-Far” problem
- CDMA Cellular, GPS Navigation, Wi-Fi
- De-spreading spreads (weakens) other non-correlated signals

Frequency Hopping

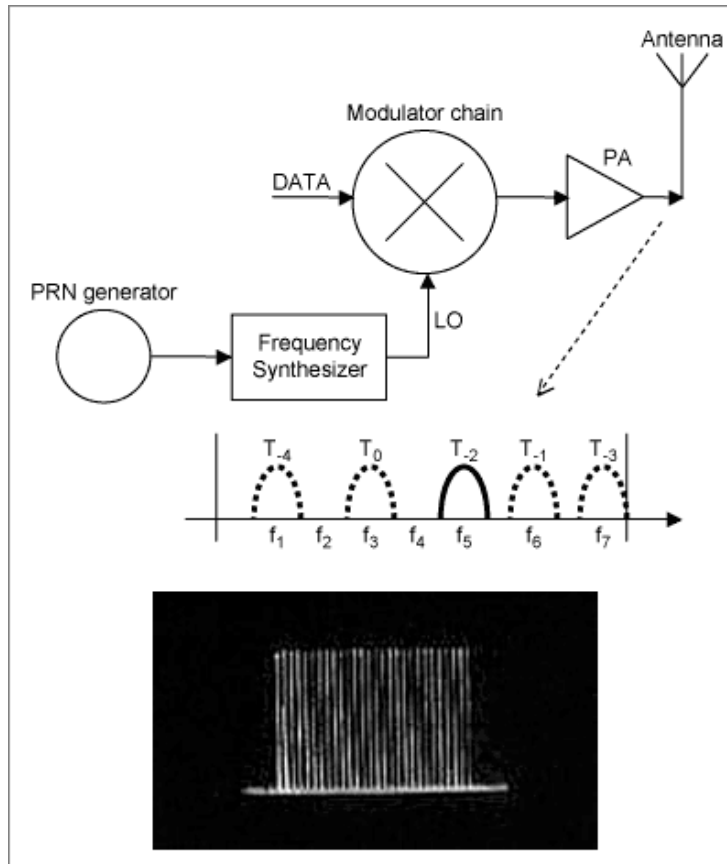

- Code controls instantaneous frequency of transmission
- “Graceful Degradation”
- GSM Cellular, Bluetooth
- Resilient against Fading
- Bit-Rate Hopping resilient against Inter-symbol Interference